

MADE IN ITALY. MADE TO EXCEL.

MARVEL

TRAVERTINE

Interactive version



 atlas concorde

April 2023

Porcelain tiles: a safe choice.

HYGIENIC
Igienico

RECYCLABLE
Riciclabile

VERSATILE
Versatile

SAFE
Sicuro

FIREPROOF
Non brucia

EASY TO CLEAN AND DISINFECT
Facile da pulire e sanificare

RESISTANT
Resistente

ECO-FRIENDLY
Ama l'ambiente

LONG LASTING
Dura a lungo

ZERO PVC
Zero PVC

INDEX



OVERVIEW



HBA
HIRSCH
BEDNER
ASSOCIATES



IMAGE
GALLERY



SURFACE
RANGE &
TECHNICAL
SPECS



COLLECTION RANGE
MARVEL WORLD
TECHNICAL SPECIFICATIONS
& CERTIFICATIONS

ENJOY
THE VIDEO
EN | IT | FR | DE | RU







Porcelain tiles



PORCELAIN TILES - Gres Porcellanato - Grès cérame - Feinsteinzeug - Gres porcelánico - Керамический гранит

RECTIFIED MONOCALIBER - Rettificato monocalibro - Rectifié mono-calibre - Geschliffen einkalibrig - Rectificado monocalibre - Ретифицированный в одном калибре

VEIN CUT

		White	Sand	Pearl
  Floor & Wall Furniture 120x278 cm - 47 1/4" x 109 1/2" 120x240 cm - 47 1/4" x 94 1/2" 60x120 cm - 23 5/8" x 47 1/4"	± 6 mm	Matte	Matte	Matte
	± 9 mm	Matte Sensitech	Matte Sensitech	Matte Sensitech
	± 9 mm	Matte Sensitech	Matte Sensitech	Matte Sensitech
  Countertops Furniture 162x324 cm - 63 3/4" x 127 1/2" > Non rectified - non rettificato	± 6 mm		Hammered	
	± 12 mm		Hammered	
				Hammered
 Outdoor 60x120 cm - 23 5/8" x 47 1/4" 60x120 cm - 23 5/8" x 47 1/4"	± 9 mm	Grip Sensitech	Grip Sensitech	Grip Sensitech
	± 20 mm	Outdoor Sensitech	Outdoor Sensitech	Outdoor Sensitech

CROSS CUT

		White	Sand	Pearl
  Floor & Wall Furniture 120x120 cm - 47 1/4" x 47 1/4" 60x120 cm - 23 5/8" x 47 1/4" 60x60 cm - 23 5/8" x 23 5/8"	± 9 mm	Matte Sensitech	Matte Sensitech	Matte Sensitech
	± 9 mm	Matte Sensitech	Matte Sensitech	Matte Sensitech
	± 9 mm	Matte Sensitech	Matte Sensitech	Matte Sensitech
 Outdoor 60x120 cm - 23 5/8" x 47 1/4"	± 9 mm	Grip Sensitech	Grip Sensitech	Grip Sensitech

Sensitech

SAFE. SOFT. SMART.

pag.120

The constant research of Atlas Concorde Laboratories has led to the creation of Sensitech, the porcelain tile surface for interiors made using a production method patented in Italy that combines superior slip-resistance with an unprecedented tactile softness, guaranteeing ease of cleaning and maintenance.

Dalla costante ricerca dei Laboratori Atlas Concorde nasce Sensitech, la superficie in gres porcellanato per interni realizzata con metodo produttivo brevettato in Italia, che associa elevate prestazioni di resistenza allo scivolamento ad un'inedita morbidezza tattile, garantendo facilità di pulizia e manutenzione.

Destination of use

 Matte ± 6 mm	 Matte ± 9 mm Matte Sensitech ± 9 mm Grip ± 9 mm Outdoor ± 20 mm
--	--

Anti-slip

 R9 Matte ± 6 mm R10 B Matte, Matte Sensitech ± 9 mm R11 C Grip Sensitech ± 9 mm R11 C Outdoor Sensitech ± 20 mm
--

Color-shading

V3 Moderate Variation



WHITE VEIN CUT

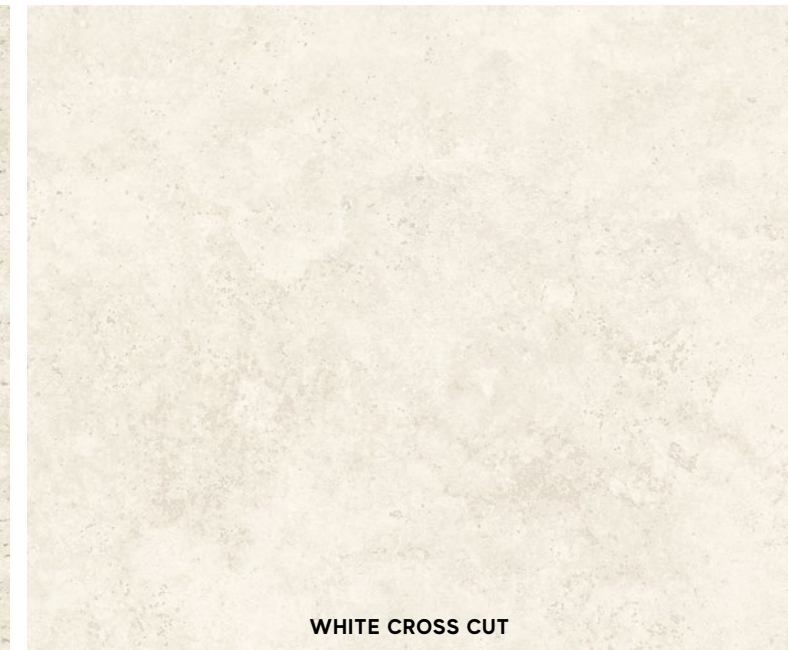

WHITE CROSS CUT



SAND VEIN CUT



SAND CROSS CUT



PEARL VEIN CUT

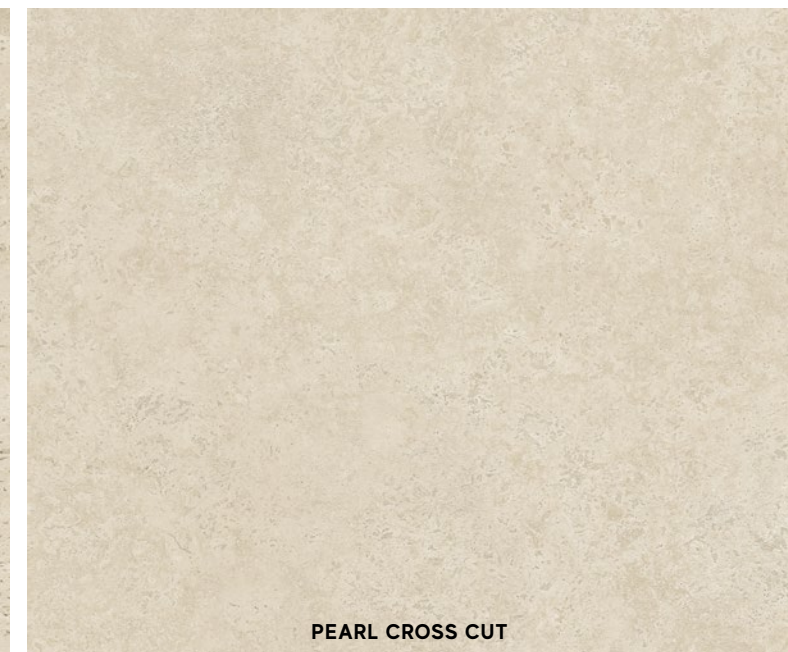

PEARL CROSS CUT

INDEX



OVERVIEW



HBA
HIRSCH
BEDNER
ASSOCIATES



IMAGE
GALLERY



SURFACE
RANGE &
TECHNICAL
SPECS



COLLECTION RANGE
MARVEL WORLD
TECHNICAL SPECIFICATIONS
& CERTIFICATIONS

ENJOY
THE VIDEO
EN | IT | FR | DE | RU



Porcelain Tiles Decors



Marvel Travertine Travertino White
Mosaico Origami
28x41,2 cm - 11"x16¹/₄"



Marvel Travertine Travertino Sand
Mosaico Origami
28x41,2 cm - 11"x16¹/₄"



Marvel Travertine Travertino Pearl
Mosaico Origami
28x41,2 cm - 11"x16¹/₄"

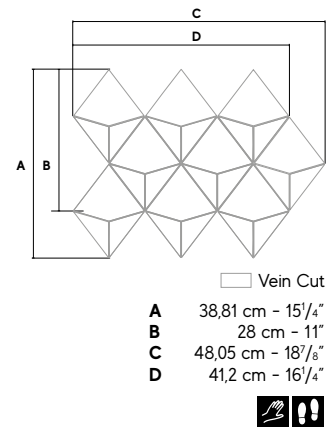

Marvel Travertine Travertino White
Diamond ⁽¹⁾
60x60 cm - 23⁵/₈"x23⁵/₈"

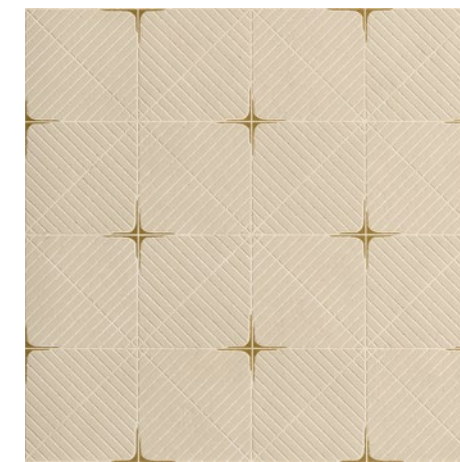

Marvel Travertine Travertino Sand
Diamond ⁽¹⁾
60x60 cm - 23⁵/₈"x23⁵/₈"



Marvel Travertine Travertino Pearl
Diamond ⁽¹⁾
60x60 cm - 23⁵/₈"x23⁵/₈"



Marvel Travertine Travertino White
Mosaico Basketweave
35x46,8 cm - 13³/₄"x18³/₄"



Marvel Travertine Travertino Sand
Mosaico Basketweave
35x46,8 cm - 13³/₄"x18³/₄"



Marvel Travertine Travertino Pearl
Mosaico Basketweave
35x46,8 cm - 13³/₄"x18³/₄"

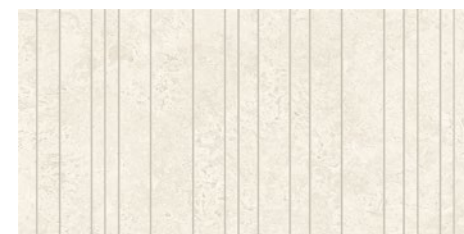
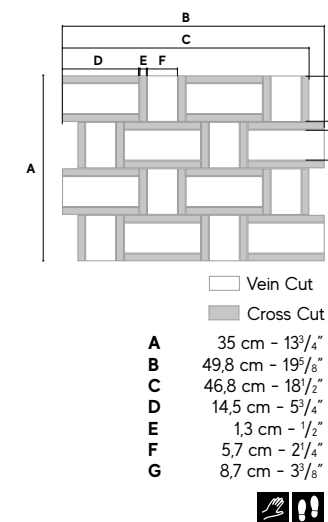

Marvel Travertine Travertino White
Cross Chiselled Urban Grid ⁽²⁾
30x60 cm - 11³/₄"x23⁵/₈"

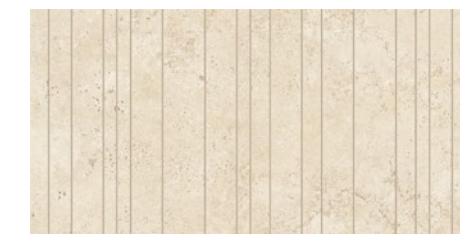

Marvel Travertine Travertino Sand
Cross Chiselled Urban Grid ⁽²⁾
30x60 cm - 11³/₄"x23⁵/₈"

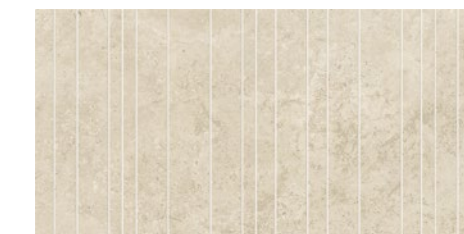

Marvel Travertine Travertino Pearl
Cross Chiselled Urban Grid ⁽²⁾
30x60 cm - 11³/₄"x23⁵/₈"



For best results it is recommended to follow one of the following laying patterns. - Per un risultato estetico ottimale si consiglia di seguire uno dei seguenti schemi di posa. - Nous vous invitons à respecter un des schémas de pose suivants pour un résultat esthétique optimal. - Für ein optisch optimales Resultat empfehlen wir, eines der nachstehenden Verlegemuster zu befolgen. - Para obtener un mejor resultado estético, es aconsejable seguir uno de los siguientes esquemas de colocación. - Для достижения наилучшего эстетического результата рекомендуется использовать одну из следующих схем укладки.



Marvel Travertine Travertino White
Mosaico Tessellation
22x26 cm - 8⁵/₈"x10¹/₄"



Marvel Travertine Travertino Sand
Mosaico Tessellation
22x26 cm - 8⁵/₈"x10¹/₄"



Marvel Travertine Travertino Pearl
Mosaico Tessellation
22x26 cm - 8⁵/₈"x10¹/₄"

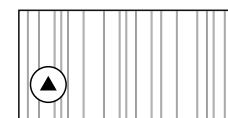
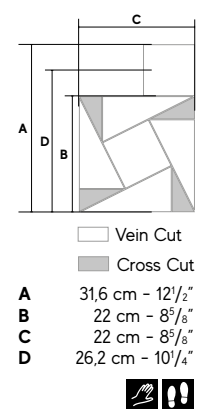

LAYING PATTERN 1

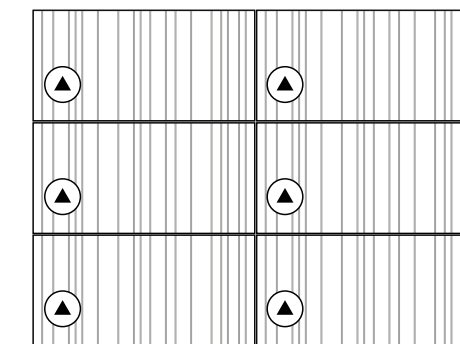

LAYING PATTERN 2

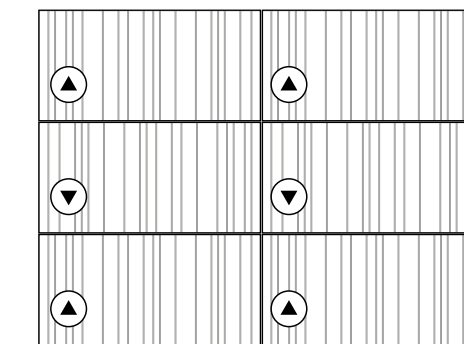

(1) Application of decorative materials. The use of a common mild detergent is recommended. Avoid using acidic or alkaline products, waxes, steel wool, or abrasives. - Applicazione di materie decorative. Si consiglia l'utilizzo di un comune detergente neutro. Evitare l'utilizzo di prodotti acidi o alcalini, ceranti e pagliette di metallo o abrasive. - Application de matériaux décoratifs. Nous conseillons l'emploi de détergents neutres courants. Éviter l'utilisation de cires et de produits acides ou alcalins, ainsi que les pailles métalliques ou abrasives. - Dekorationsmaterial. Es empfiehlt sich, ein haushaltsübliches, neutrales Reinigungsmittel zu verwenden. Saure oder alkalische Produkte, Wachs sowie Stahlwolle- bzw. Scheuerschwämme sind zu vermeiden. - Aplicación de materiales decorativos. Recomendamos utilizar un detergente neutro común. Hay que evitar el uso de productos ácidos o alcalinos, ceras y estropajos de metal o abrasivos. - Применение декоративных материалов. Рекомендуется очистить обычным нейтральным моющим средством. Не рекомендуется использовать кислотные, щелочные, восковые средства, а также металлические моющие средства.

(2) Engraved mosaic. For best results it is advisable to completely plaster the engravings. - Mosaico inciso, per risultato ottimale si consiglia di stuccare completamente le incisioni. - Mosaïque gravée, pour de meilleurs résultats, il est recommandé de remplir complètement les gravures. - Graviertes Mosaik, für ein optimales Resultat sollten die Gravuren vollständig verspachtelt werden. - Mosaico grabado, para obtener los mejores resultados se recomienda enmasillar el grabado en su totalidad. - Высеченная мозаика. Для оптимального результата рекомендуется полностью заделывать углубления затиркой.